

Title		
Size	Number	Revision
A4		
Date:	3-May-2017	Sheet of
File:	C:\Users\tr\Desktop\V3\sch\OVMS V3.d	Drawn By:

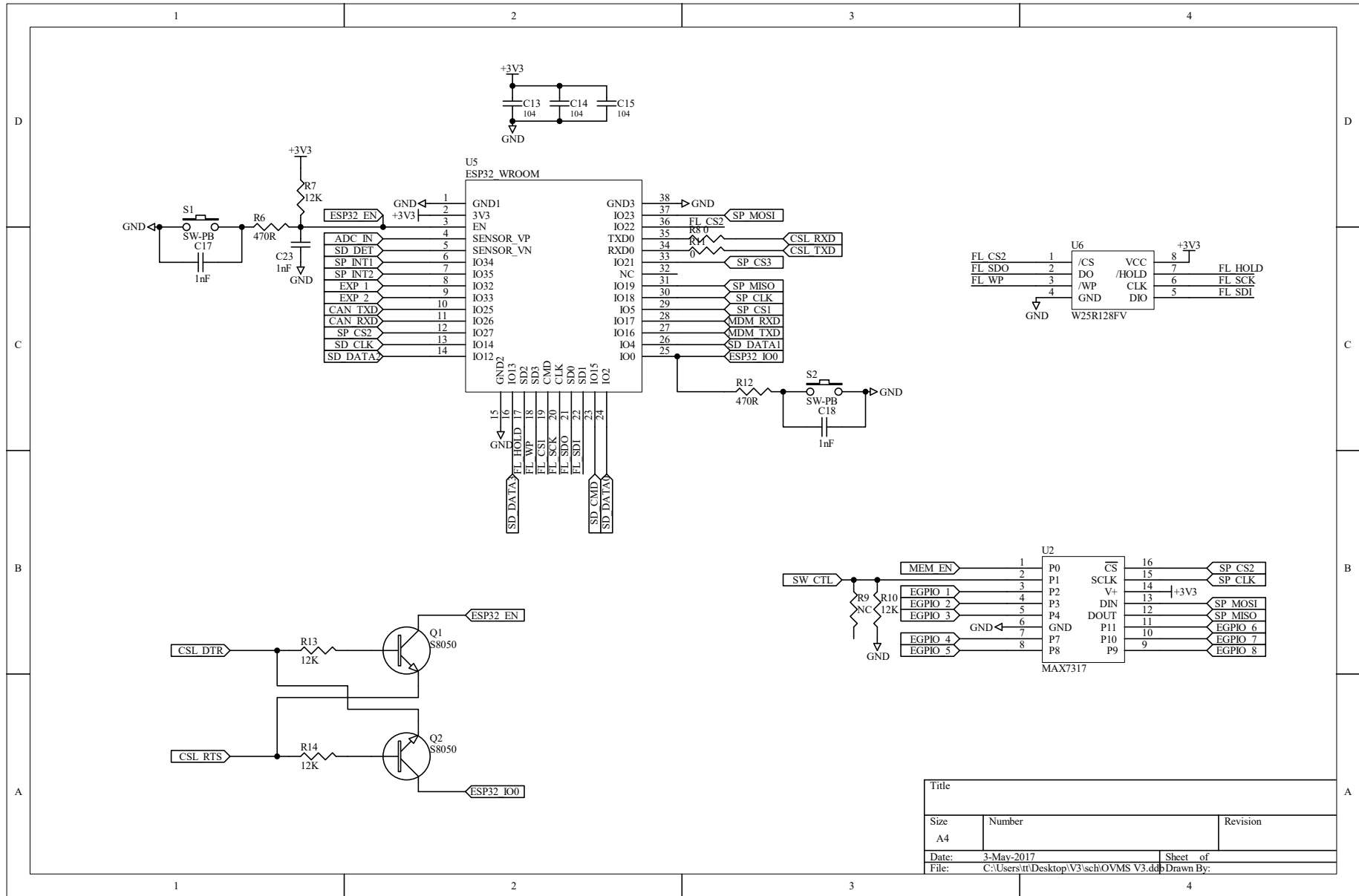

Title		
Size	Number	Revision
A4		
Date:	3-May-2017	Sheet of
File:	C:\Users\tr\Desktop\V3\sch\OVMS V3.d	Drawn By:

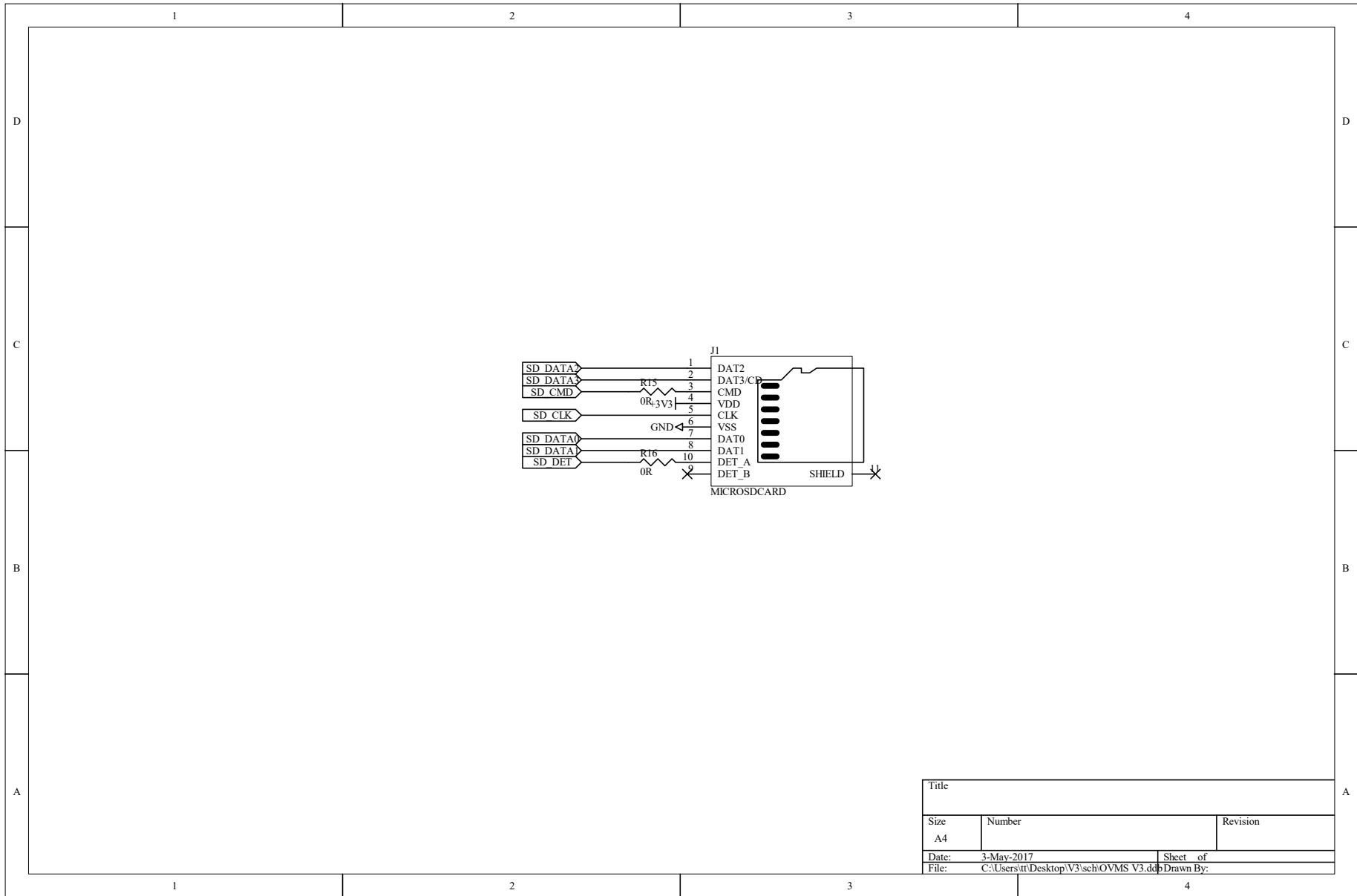

Title		
Size	Number	Revision
A4		
Date:	3-May-2017	Sheet of
File:	C:\Users\tr\Desktop\V3\sch\OVMS V3.d	Drawn By:

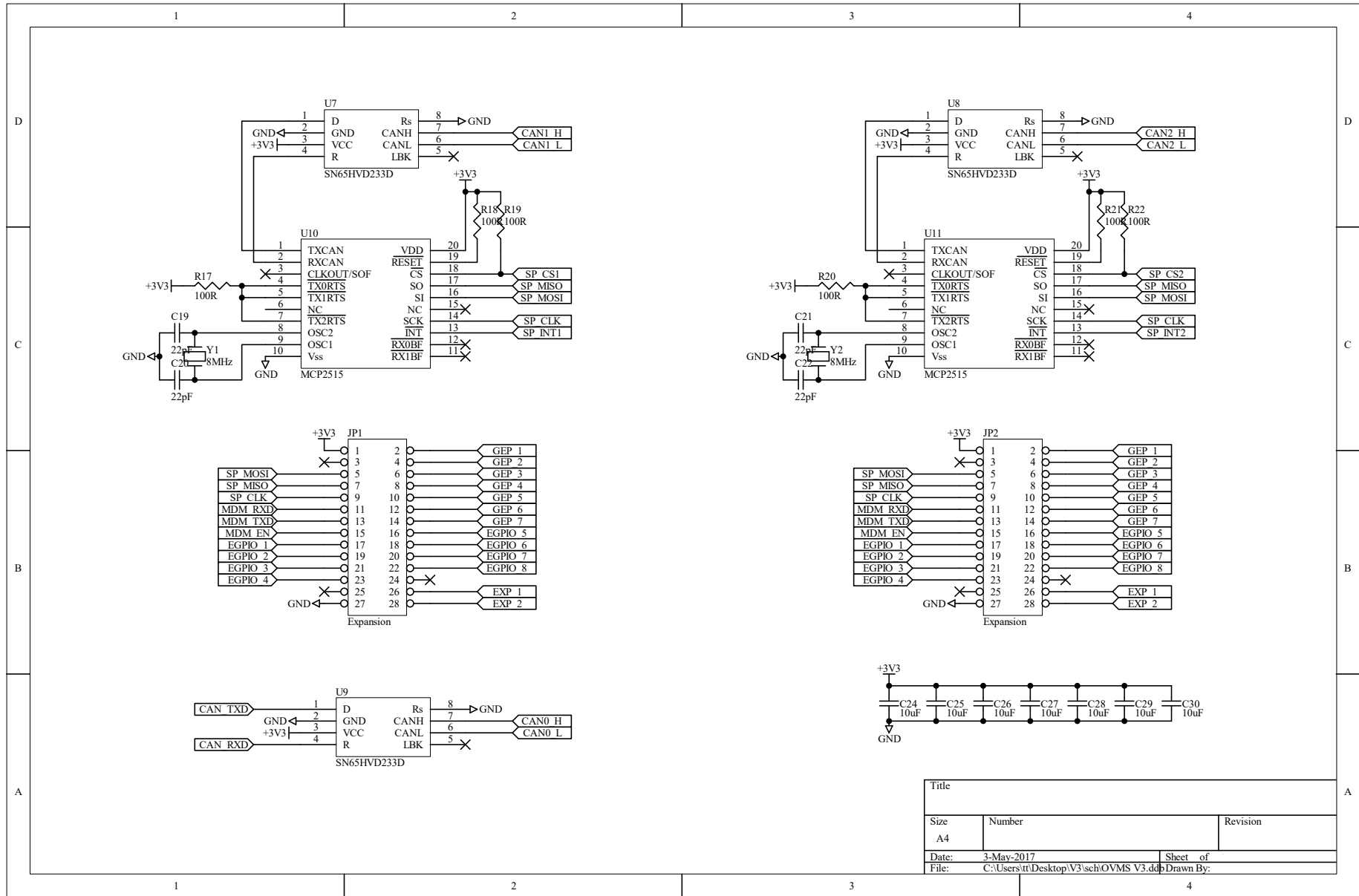

Title		
Size	Number	Revision
A4		
Date:	3-May-2017	Sheet of
File:	C:\Users\tr\Desktop\V3\sch\OVMS V3.dcb	Drawn By:

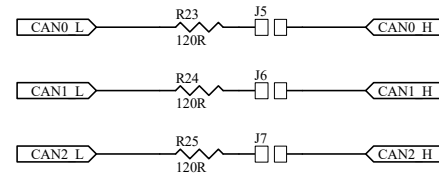
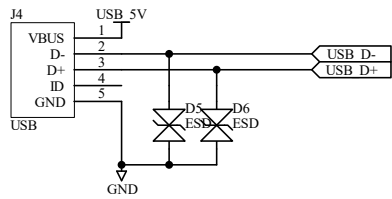
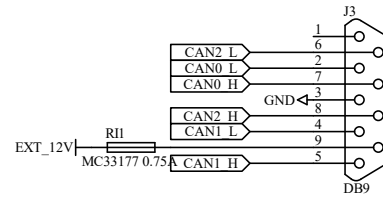
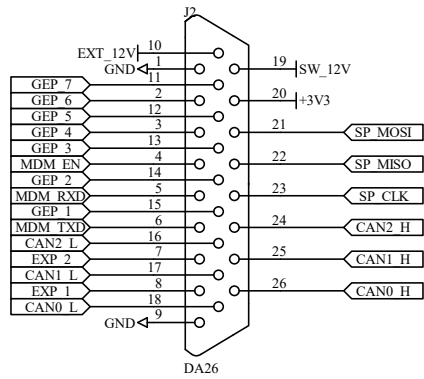

Title		
Size	Number	Revision
A4		
Date:	3-May-2017	Sheet of
File:	C:\Users\tr\Desktop\V3\sch\OVMS V3.d	Drawn By: