

	1	2	3	4	5	6
A					Sheet: Expansion File: Expansion.sch	
B			Sheet: MCU File: MCU.sch			
C	Sheet: Power and USB File: PowerUSB.sch				Sheet: Connectors File: Connectors.sch	
D			Sheet: Storage File: Storage.sch	Sheet: / File: OVMS v3.sch Title: Size: A4 Date: KiCad E.D.A. kicad 4.0.6 Rev: Id: 1/6		
	1	2	3	4	5	6

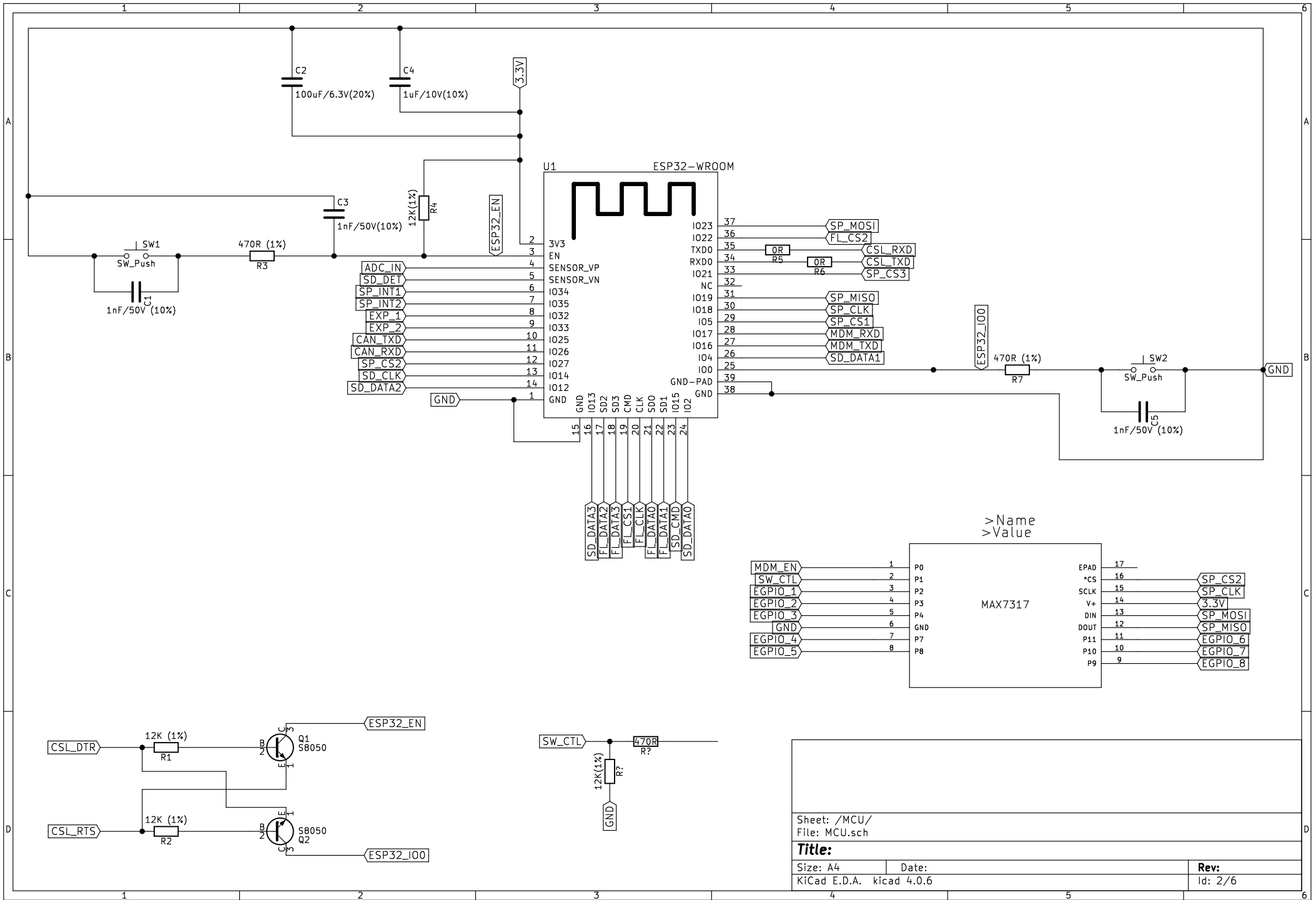

Sheet: /MCU/		Date:	
File: MCU.sch		Rev:	
Title:		Id: 2/6	
Size: A4	KiCad E.D.A. kicad 4.0.6		

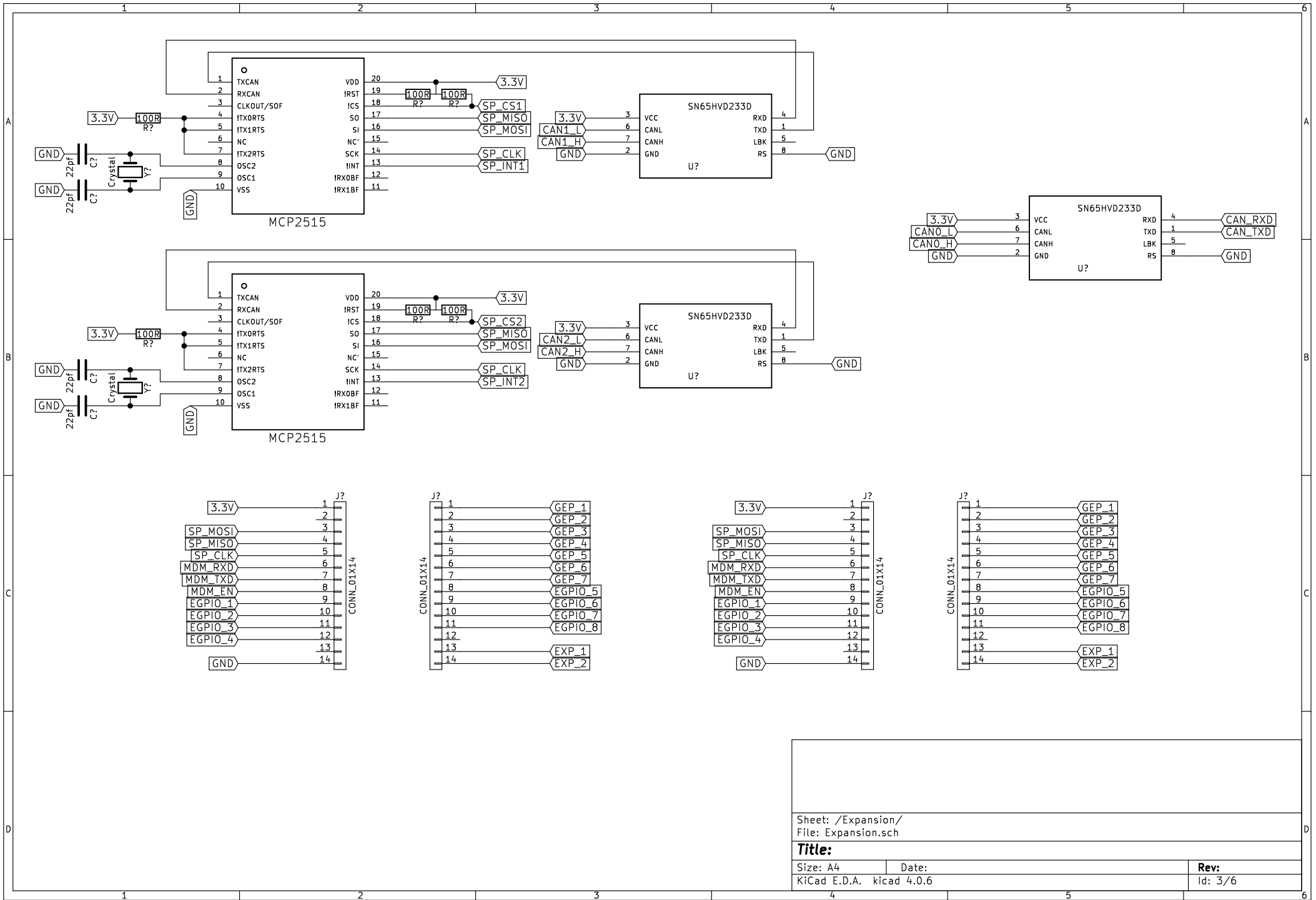

Sheet: /Expansion/
File: Expansion.sch

Title:

Size: A4
KiCad E.D.A. kicad 4.0.6

Date:

Rev:
Id: 3/6

DA26_FEMALE_HighDensity

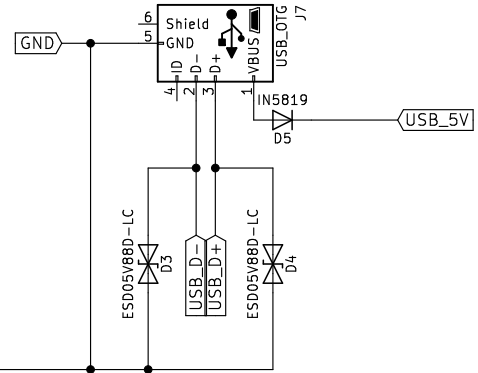
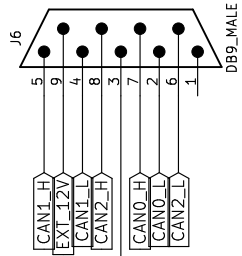
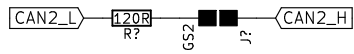
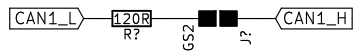
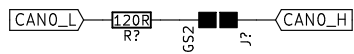
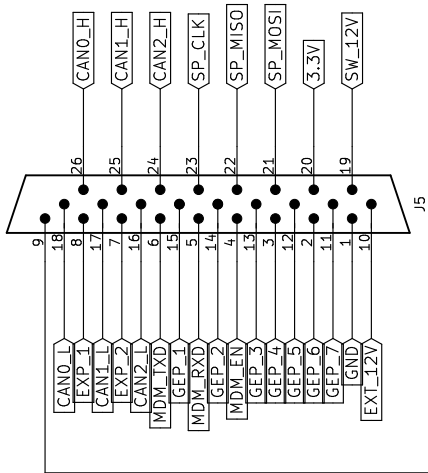

Sheet: /Connectors/
File: Connectors.sch

Title:

Size: A4 Date:
KiCad E.D.A. kicad 4.0.6

Rev:
Id: 4/6

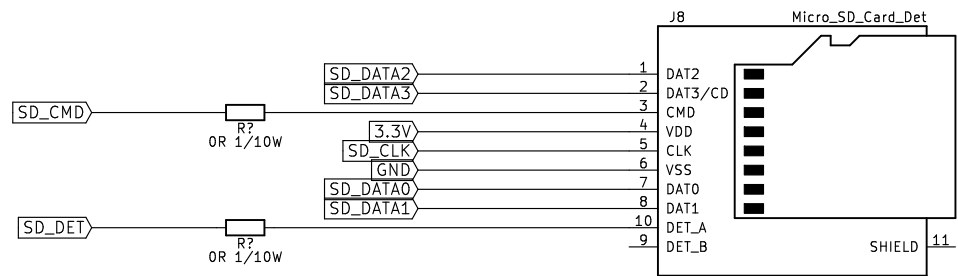

Sheet: /Storage/
File: Storage.sch

Title:

Size: A4

Date:

KiCad E.D.A. kicad 4.0.6

Rev:

Id: 5/6

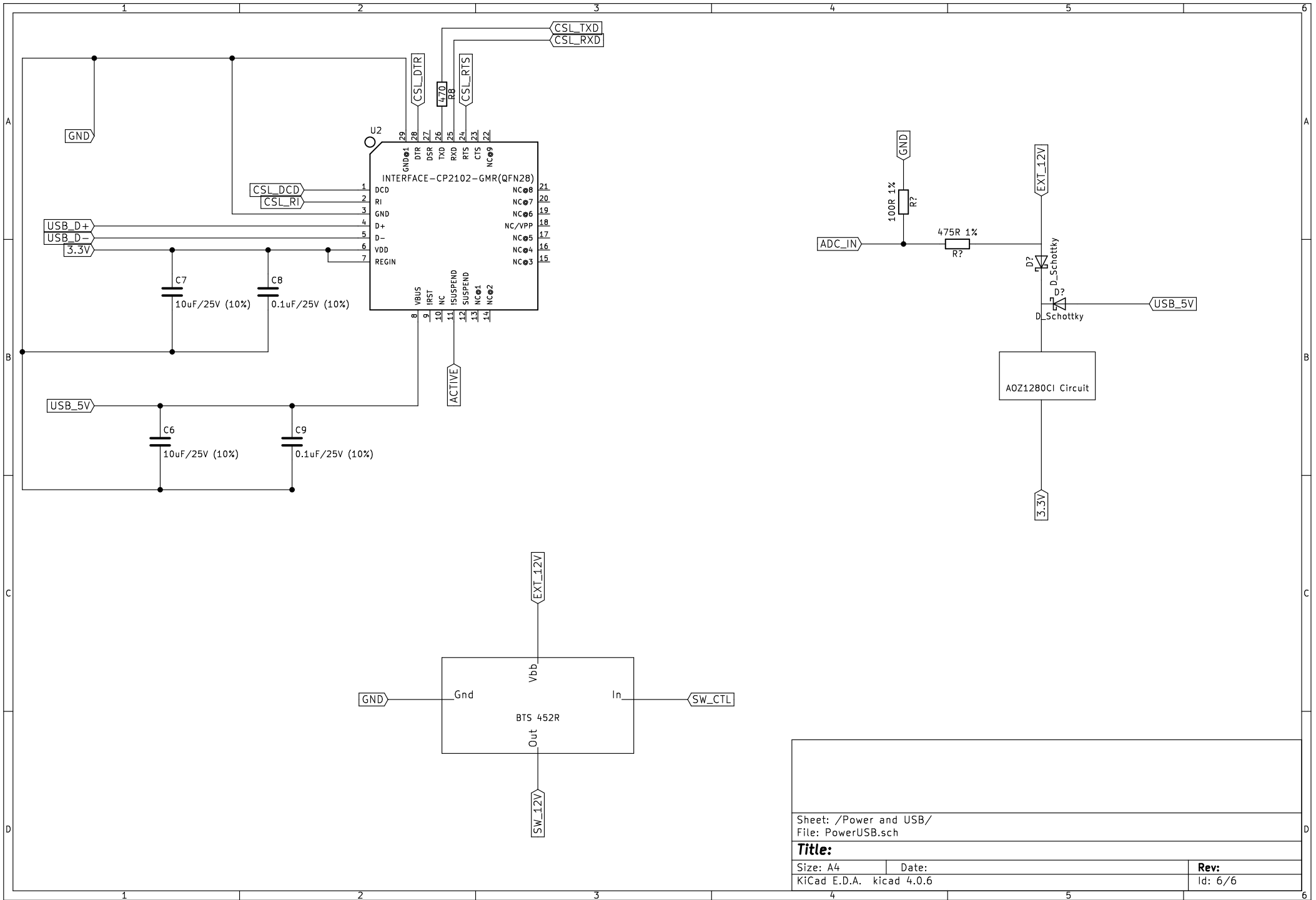

Sheet: /Power and USB/ File: PowerUSB.sch		
Title:		
Size: A4	Date:	Rev:
KiCad E.D.A. kicad 4.0.6		Id: 6/6